

# Absolute encoders – multiturn

<b>Compact, robust electronic multiturn, magnetic</b>	<b>Sendix M3661R (shaft)</b>	<b>Analog</b>
---	------------------------------	---------------



The Sendix M36 with Energy Harvesting Technology is an electronic multiturn encoder in miniature format, without gear and without battery.

The "R"obust version is particularly suitable for use in harsh environments. Protected up to IP69k, resistance against shock and extreme temperature fluctuations, the Sendix M36 encoder is suitable even for demanding outdoor applications.



Safety-Lockplus™	Standard option stainless steel 1.4404	Standard option seawater resistant	High rotational speed	Temperature range -40°...+85°C	High protection level IP	High shaft load capacity	Shock / vibration resistant	Reverse polarity protection	Energy Harvesting

## Highest robustness

- Sturdy bearing construction in Safety-Lockplus™ design for particularly high resistance.
- Extra large bearings.
- Mechanically protected shaft seal.
- Protection level IP66, IP67 and IP69k in one device.
- Wide temperature range -40 °C ... +85 °C.
- Without gear and without battery, thanks to the Energy Harvesting technology.

## Application oriented

- Current output 4 ... 20 mA.
- Voltage output 0 ... 10 V or 0 ... 5 V.
- Measuring range scalable.
- Limit switch function.

<b>Order code</b>	<b>Shaft version</b>	<b>8.M3661R.XXXXX.XX12</b>
		Type    a   b   c   d   e   f

### a Version

- 1 = standard <sup>1)</sup>  
clamping flange ø 42 mm [1.65"]
- 7 = stainless steel V4A <sup>2)</sup>  
clamping flange ø 42 mm [1.65"]  
all metal parts accessible from outside are out of stainless steel V4A

### b Shaft (ø x L), with flat

- 1 = ø 6 x 12.5 mm [0.24 x 0.49"]
- 3 = ø 8 x 15 mm [0.32 x 0.59"]
- 5 = ø 10 x 20 mm [0.39 x 0.79"]
- 2 = ø 1/4" x 12.5 mm [0.49"]
- E = ø 10 x 20 mm [0.39 x 0.79"], stainless steel V4A

### c Output circuit <sup>3)</sup>

- 3 = current output
- 4 = voltage output

### d Type of connection

- 2 = radial cable, 1 m [3.28'] PVC
- B = radial cable, special length PVC \*)
- 4 = radial M12 connector, 5-pin

\*) Available special lengths (connection types B):  
2, 3, 5, 8, 10, 15 m [5.56, 9.84, 16.40, 26.25, 32.80, 49.21']  
order code expansion .XXXX = length in dm  
ex.: 8.M3661R.133B.3112.0030 (for cable length 3 m)

### e Interface / resolution / supply voltage

- 3 = 4 ... 20 mA / 12 bit / 10 ... 30 V DC
- 4 = 0 ... 10 V / 12 bit / 15 ... 30 V DC
- 5 = 0 ... 5 V / 11 bit / 10 ... 30 V DC

### f Measuring range

- 1 = 16 revolutions / cw
- 2 = 16 revolutions / ccw
- 3 = scalable up to 65,536 revolutions, with limit switch function / cw
- 4 = scalable up to 65,536 revolutions, without limit switch function / cw
- 5 = scalable up to 65,536 revolutions, with limit switch function / ccw
- 6 = scalable up to 65,536 revolutions, without limit switch function / ccw

### Optional on request

- Ex 2/22 (only for connection type 4)
- other shaft diameters out of V4A stainless steel

1) Not in conjunction with shaft type "E".  
2) Only in conjunction with shaft type "E" + type of connection "4".  
3) Output circuit "3" only in conjunction with interface "3",  
output circuit "4" only in conjunction with interface "4" or "5".

# Absolute encoders – multiturn

<b>Compact, robust electronic multiturn, magnetic</b>	<b>Sendix M3661R (shaft)</b>	<b>Analog</b>
<b>Mounting accessory for shaft encoders</b>		Order no.
<b>Coupling</b>	Bellows coupling ø 19 mm [0.75"] for shaft 8 mm [0.32"]	<b>8.0000.1102.0808<sup>1)</sup></b>
<b>Cables and connectors</b>		Order no.
<b>Preassembled cables</b>	M12 female connector with coupling nut, 5-pin, A coded, straight single ended 2 m [6.56'] PVC cable	<b>05.00.6081.2211.002M<sup>1)</sup></b>
<b>Connectors</b>	M12 female connector with coupling nut, 5-pin, A coded, straight (metal)	<b>8.0000.5116.0000<sup>1)</sup></b>
	M12 female connector with coupling nut, 5-pin, A coded, straight (stainless steel V4A)	<b>8.0000.5116.0000.V4A</b>

Further Kübler accessories can be found at: [kuebler.com/accessories](http://kuebler.com/accessories)  
 Further Kübler cables and connectors can be found at: [kuebler.com/connection-technology](http://kuebler.com/connection-technology)

## Technical data

Electrical characteristics current interface 4 ... 20 mA	
<b>Supply voltage</b>	10 ... 30 V DC
<b>Current consumption (no load)</b>	max. 30 mA
<b>Reverse polarity protection of the supply voltage</b>	yes
<b>Short-circuit proof outputs</b>	yes <sup>2)</sup>
<b>Measuring range</b>	factory setting 2 <sup>4</sup> revolutions optionally scalable up to 2 <sup>16</sup> revolutions
<b>DA converter resolution</b>	12 bit
<b>Angular measurement deviation<sup>3)</sup></b>	±0,5°
<b>Temperature coefficient</b>	< 100 ppm/K
<b>Repeat accuracy, at 25 °C [77 °F]</b>	±0,2°
<b>Output load</b>	at 10 V DC max. 200 Ohm at 24 V DC max. 900 Ohm at 30 V DC max. 1200 Ohm
<b>Setting time</b>	< 1 ms, R <sub>Burden</sub> = 900 Ohm, 25 °C [77 °F]
<b>LEDs (green/red)</b>	- system status - current loop interruption – input load too high - reference point display (only with factory settings) at cw: betw. 0° and 1° at ccw: betw. 0° and -1° - status in teach mode
<b>Options</b>	- output signal scalable via the teach inputs - output signal scalable via the teach inputs + limit switch function
<b>Teach inputs</b>	level = +V for 1 s minimum
<b>PowerON Time</b>	< 1 s
<b>Update rate</b>	1 ms

Electrical characteristics voltage interface 0 ... 10 V / 0 ... 5 V	
<b>Supply voltage</b>	output 0 ... 5 V 10 ... 30 V DC output 0 ... 10 V 15 ... 30 V DC
<b>Current consumption (no load)</b>	max. 30 mA
<b>Reverse polarity protection of the supply voltage</b>	yes
<b>Short-circuit proof outputs</b>	yes <sup>2)</sup>
<b>Measuring range</b>	factory setting 2 <sup>4</sup> revolutions optionally scalable up to 2 <sup>16</sup> revolutions
<b>DA converter resolution</b>	0 ... 10 V 12 bit 0 ... 5 V 11 bit
<b>Angular measurement deviation<sup>3)</sup></b>	±0,5°
<b>Temperature coefficient</b>	< 100 ppm/K
<b>Repeat accuracy, at 25 °C [77 °F]</b>	±0,2°
<b>Current output</b>	max. 10 mA
<b>Setting time</b>	< 1 ms, R <sub>Load</sub> = 1000 Ohm, 25 °C [77 °F]
<b>LEDs (green/red)</b>	- system status - reference point display (only with factory settings) at cw: betw. 0° and 1° at ccw: betw. 0° and -1° - status in teach mode
<b>Options</b>	- output signal scalable via the teach inputs - output signal scalable via the teach inputs + limit switch function
<b>Teach inputs</b>	level = +V for 1 s minimum
<b>PowerON Time</b>	< 1 s
<b>Update rate</b>	1 ms

1) Not for version "7" (V4A stainless steel)  
 2) When the supply voltage is correctly applied.  
 But not output to +V. Supply voltage and sensor output signal are not galvanically isolated.  
 3) Over the whole temperature range.

# Absolute encoders – multturn

<b>Compact, robust electronic multturn, magnetic</b>	<b>Sendix M3661R (shaft)</b>	<b>Analog</b>
--	------------------------------	---------------

Mechanical characteristics		
<b>Maximum speed</b>	4000 min <sup>-1</sup> 2000 min <sup>-1</sup> (continuous)	
<b>Starting torque at 20 °C [68 °F]</b>	< 0.01 Nm	
<b>Shaft load capacity</b>	radial	80 N
	axial	40 N
<b>Weight</b>	approx. 250 g [8.82 oz]	
<b>Protection acc. to EN 60529/DIN 40050-9</b>	IP66, IP67, IP69k	
<b>Working temperature range</b>	-40 °C ... +85 °C [-40 °F ... +185 °F]	
<b>Materials</b>	<b>version "1"</b> (standard)	<b>version "7"</b> (stainless steel)
	shaft	V2A
	flange	aluminum
	housing	zinc die-cast
	cable	PVC
		V4A
		V4A
		–
<b>Shock resistance acc. to EN 60068-2-27</b>	5000 m/s <sup>2</sup> , 4 ms	
<b>Vibration resistance acc. to EN 60068-2-6</b>	300 m/s <sup>2</sup> , 10 ... 2000 Hz	

Approvals	
<b>E1 compliant</b> in accordance with	ECE guideline
<b>UL compliant</b> in accordance with	File no. E224618
<b>CE compliant</b> in accordance with	
EMC Directive	2014/30/EU
RoHS Directive	2011/65/EU
ATEX Directive	2014/34/EU (for Ex 2/22 variants)
<b>UKCA compliant</b> in accordance with	
EMC Regulations	S.I. 2016/1091
RoHS Regulations	S.I. 2012/3032
UKEX Regulations	S.I. 2016/1107 (for Ex 2/22 variants)

## Example (output signal evolution) – factory setting

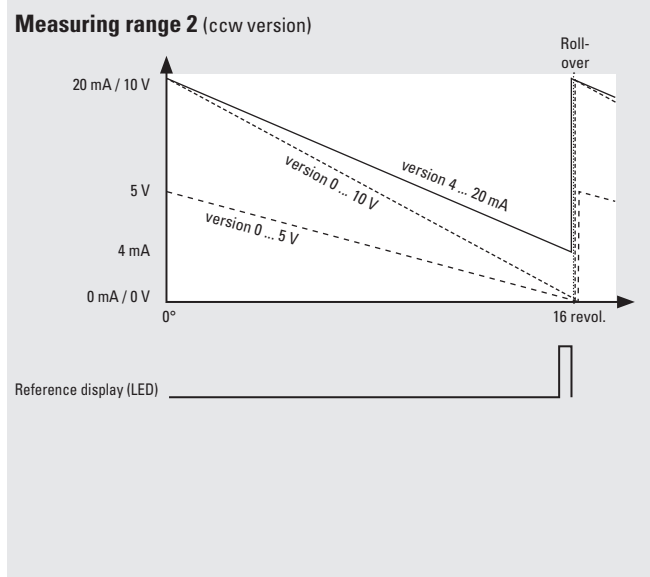
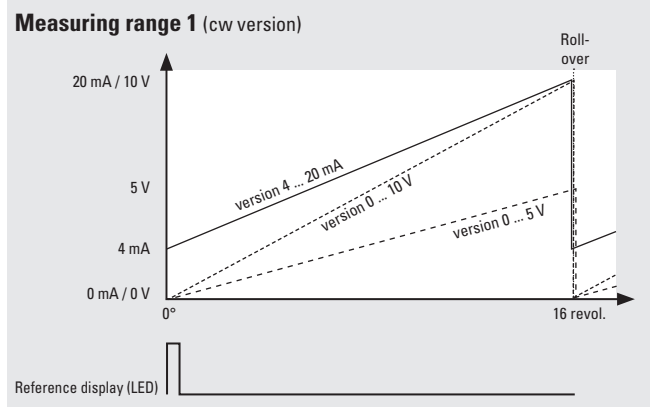

## Example (output signal evolution) – option: scalable

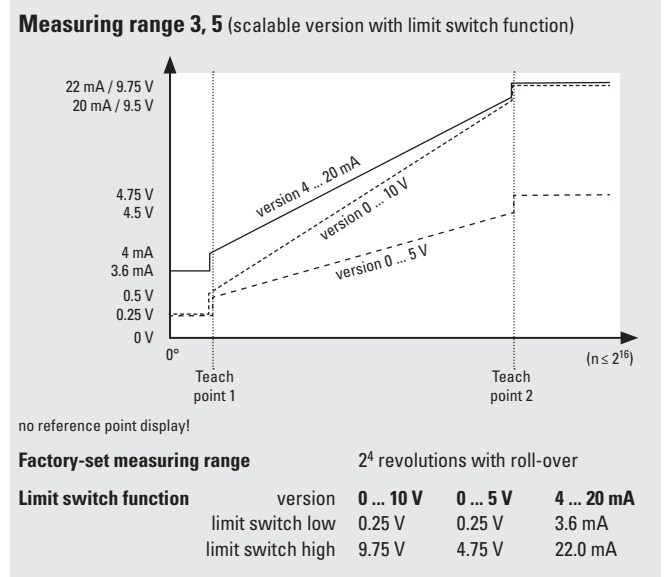
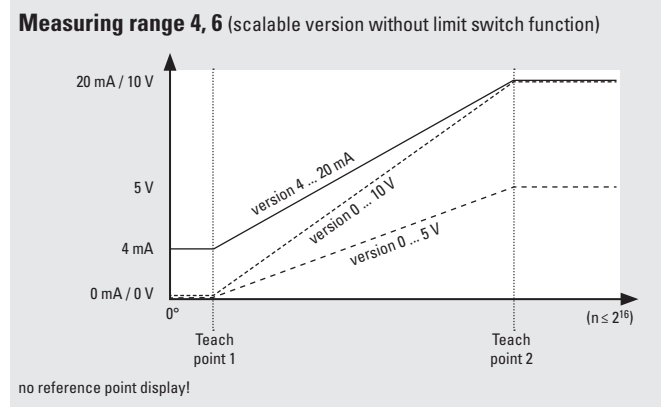

# Absolute encoders – multiturn

<b>Compact, robust electronic multiturn, magnetic</b>	<b>Sendix M3661R (shaft)</b>	<b>Analog</b>
---	------------------------------	---------------

## Terminal assignment

Interface	Type of connection	Cable (isolate unused cores individually before initial start-up)					
3 (current)	2, B	Signal:	0 V	+V	+I	SET 1 <sup>1)</sup>	SET 2 <sup>1)</sup>
		Core color:	WH	BN	GN	GY	PK

Interface	Type of connection	M12 connector, 5 pin					
3 (current)	4	Signal:	0 V	+V	+I	SET 1 <sup>1)</sup>	SET 2 <sup>1)</sup>
		Pin:	3	2	1	5	4

Interface	Type of connection	Cable (isolate unused cores individually before initial start-up)					
4, 5 (voltage)	2, B	Signal:	0 V	+V	+U	SET 1 <sup>1)</sup>	SET 2 <sup>1)</sup>
		Core color:	WH	BN	GN	GY	PK

Interface	Type of connection	M12 connector, 5 pin					
4, 5 (voltage)	4	Signal:	0 V	+V	+U	SET 1 <sup>1)</sup>	SET 2 <sup>1)</sup>
		Pin:	3	2	1	5	4

+V : Supply voltage encoder +V DC

+U : Voltage

SET 1 : Set input for teachpoint 1

0 V : Supply voltage encoder ground GND (0 V)

+I : Current

SET 2 : Set input for teachpoint 2

Top view of mating side, male contact base

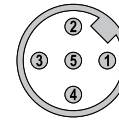

M12 connector, 5-pin

1) For scalable version.

# Absolute encoders – multiturn

<b>Compact, robust electronic multiturn, magnetic</b>	<b>Sendix M3661R (shaft)</b>	<b>Analog</b>
---	------------------------------	---------------

## Dimensions

Dimensions in mm [inch]

**Aluminum**  
clamping flange,  $\varnothing$  42 [1.65]  
version 1

1 3 x M3, 6 [0.24] deep

D	Fit	L
6 [0.24]	h7	12.5 [0.49]
8 [0.32]	h7	15 [0.59]
10 [0.39]	f7	20 [0.79]
1/4"	h7	12.5 [0.49]

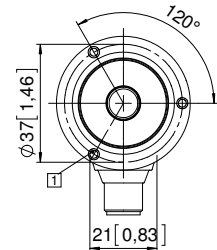
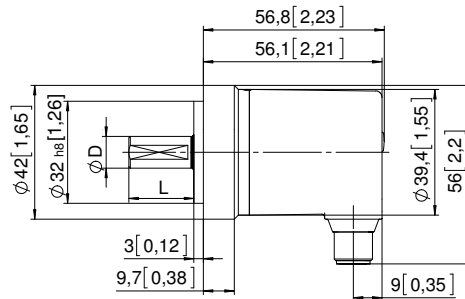

**Stainless steel V4A**  
clamping flange,  $\varnothing$  42 [1.65]  
version 7

1 4 x M4, 8 [0.31] deep

D	Fit	L
10 [0.39]	f7	20 [0.79]

